

All rights reserved, Copyright Kradox 2017		
Product model	Enclosure Z17W - Assembly	
Format: A3	Material: PS, ABS	
Scale 1:1	Tolerance: +/- 0.9	

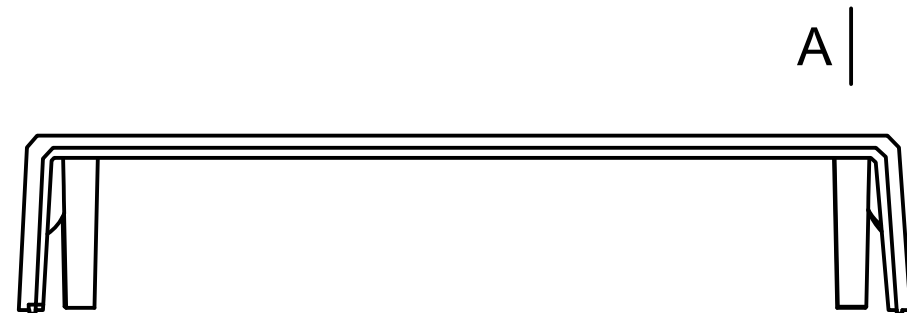
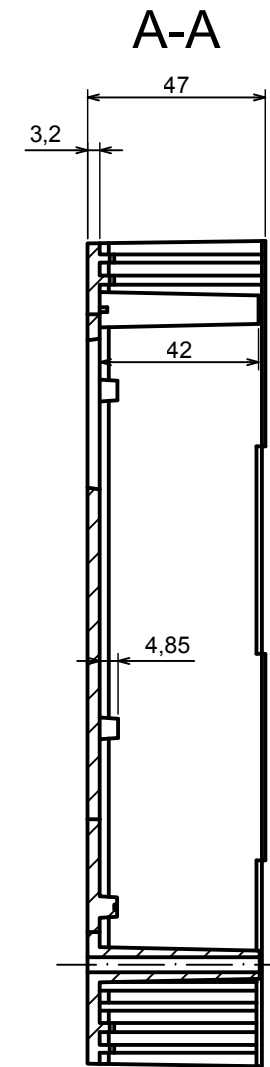
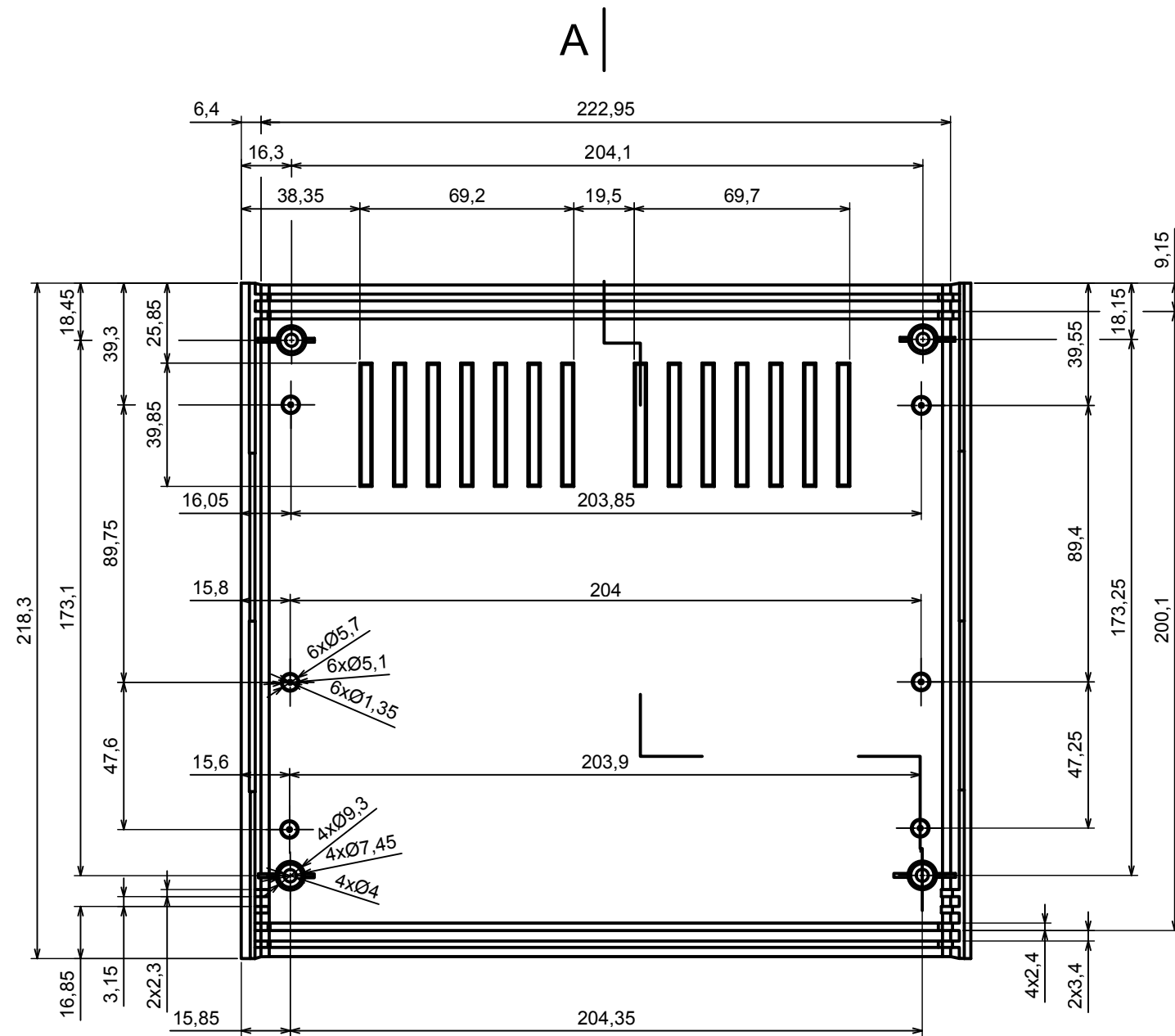

All rights reserved, Copyright Kradox 2017

Product model: Enclosure Z17W - Base

Format: A3 Material: PS, ABS

Scale 1:1 Tolerance: +/- 0.9



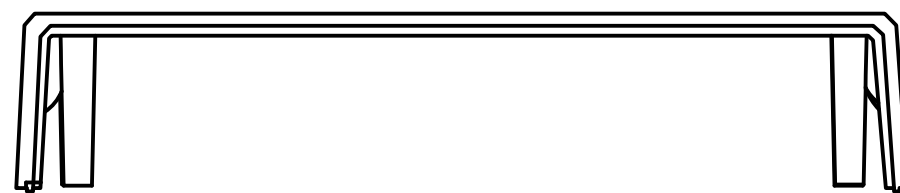
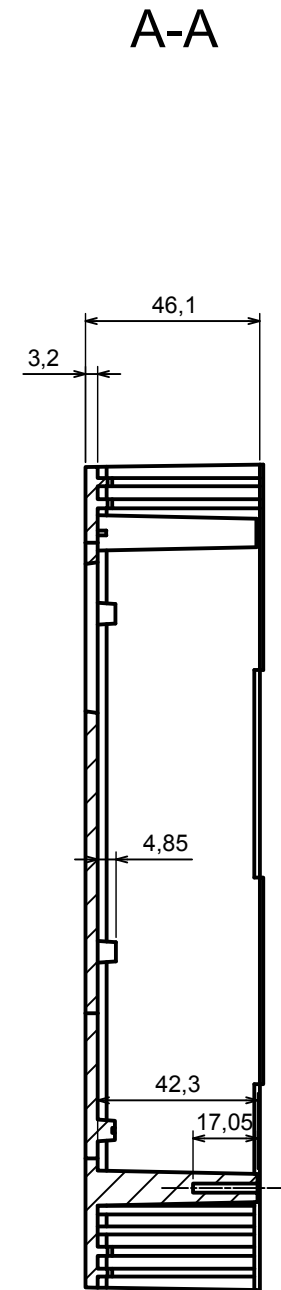
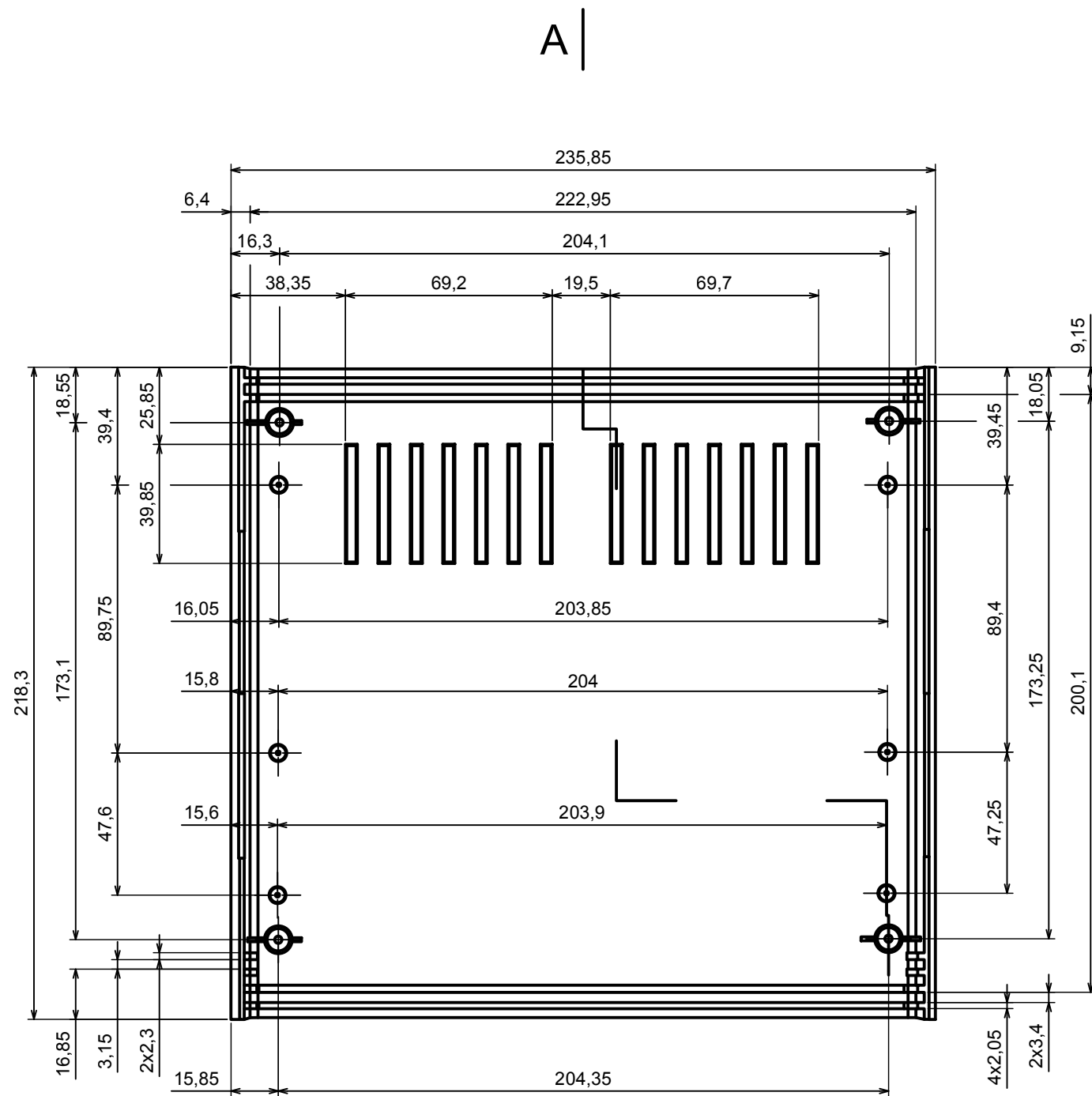

All rights reserved, Copyright Kradex 2017

Product model Enclosure Z17W - Cover

Format: A3 Material: PS, ABS

Scale 1:1 Tolerance: +/- 0.9



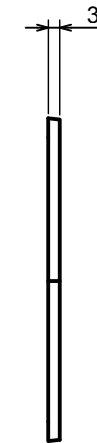
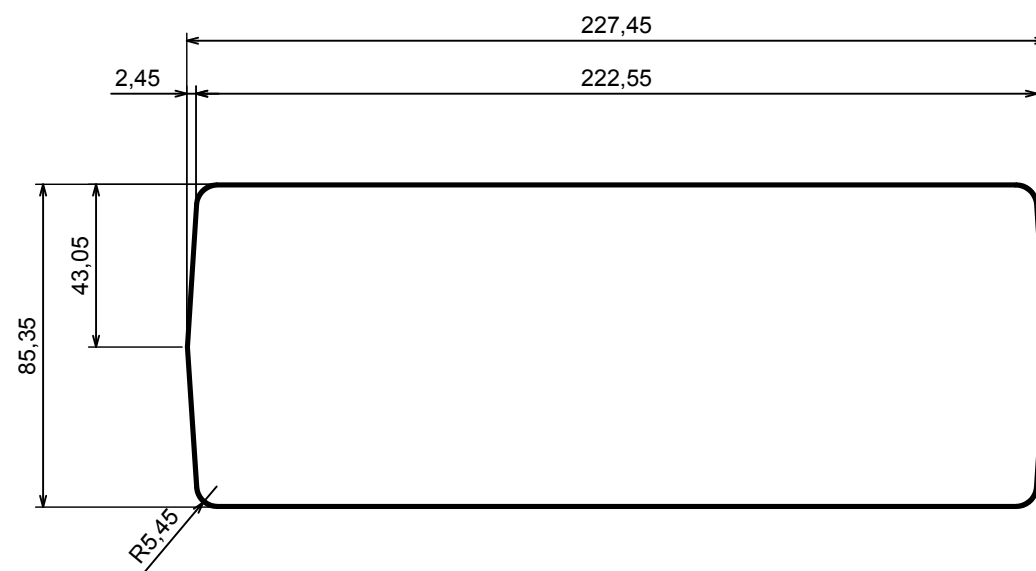

All rights reserved, Copyright Kradex 2017		
Product model	Enclosure Z17W - Board	
Format: A3	Material: PS, ABS	
Scale 1:2	Tolerance: +/- 0.9	

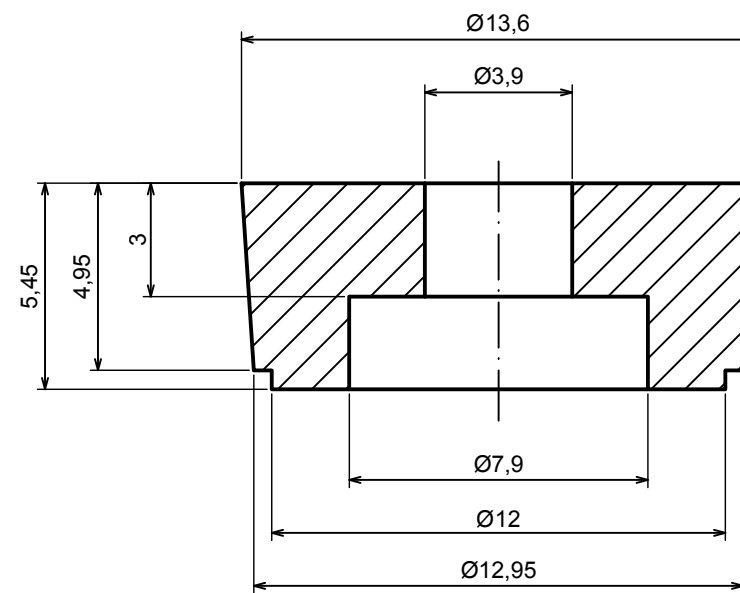

All rights reserved, Copyright Kradox 2017

Product model: Enclosure Z17W - Foot

Format: A3 Material: PS, ABS

Scale 5:1 Tolerance: +/- 0.5

