

深圳市炬烜科技有限公司
CHIP SUN TECHNOLOGY CO., LTD

**APPROVAL
SHEET**



CUSTOMER: MICROS sp.j. W.Kedra i J.Lic
DESCRIPTION: HC-49U/S 6.7458MHz Quartz Crystal Resonator
MANUFACTURER PART NO.: FTX6.745M20S-20/20BEW
CUSTOMER PART NO.:
USED IN MODEL :
REVISION A1

承 认 APPROVAL		
工程部 TECHNOLOGY DEPT.	品质部 QUALITY DEPT.	采购部 PURCHASING DEPT.

Date: March 17, 2023



深圳市炬烜科技有限公司

CHIP SUN TECHNOLOGY CO., LTD

地址 ADD: 深圳市龙华新区大浪腾龙路淘金地电子商务孵化基地 B 座 206

Rm. Rm 206, Tower B, Taojindi Building, Tenglong Road, Dalang Street, Longhua New District, Shenzhen, China

电话 TEL: 86-755-83458796 传真 FAX: 86-755-83459818

网址 WEB ADD: <http://www.chinachipsun.com>

E-MAIL: sales01@chinachipsun.com

<u>Rev</u>	<u>Revise page</u>	<u>Revise contents</u>	<u>Date</u>	<u>Ref.No.</u>	<u>Reviser</u>
A1	ALL	Initial released		N/A	DavidJiang

CHIP SUN TECHNOLOGY CO., LTD.

DESCRIPTION	HC-49/S 6.7458MHz ±20ppm 20pF	Page:
DATE	2023-03-17	2 / 6

1. QUARTZ CRYSTAL UNIT SPECIFICATION

Parameter	Specification
1.1 Frequency:	6.7458MHz
1.2 Mode of Oscillation	AT Fundamental
1.3 Holder type :	HC-49/S
1.4 Frequency tolerance:	±20ppm at 25°C±3°C
1.5. Equivalent resistance (Rr):	70Ω Max.
1.7 Operating temperature range:	-20°C To +70°C
1.8 Storage temperature range:	-40°C To +85°C
1.9. Frequency stability:	±20ppm at -20°C To +70°C
1.10 Loading capacitance (CL) :	20pF
1.11 Drive level (DL):	100 uW Typical
1.12 Shunt Capacitance (C0):	7.0pF MAX
1.13 Insulation resistance (IR) :	More than 500M ohms at DC 100V
1.14 Circuit:	Measured in S&A 250B
1.15 Aging:	±3 ppm Max (+25°C 1 st Year)
1.16 Dimensions and marking	Refer to page.3
1.17 Other	RoHS Compliant (Pb free)

Standard atmospheric conditions

Unless otherwise specified, the standard range of atmospheric conditions for making measurement and tests are as follow:

Ambient temperature : 25±3°C

Relative humidity : 40%~70%

CHIP SUN TECHNOLOGY CO., LTD.		
DESCRIPTION	HC-49/S 6.7458MHz ±20ppm 20pF	Page:
DATE	2023-03-17	3 / 6

2. MARKING & DIMENSIONS

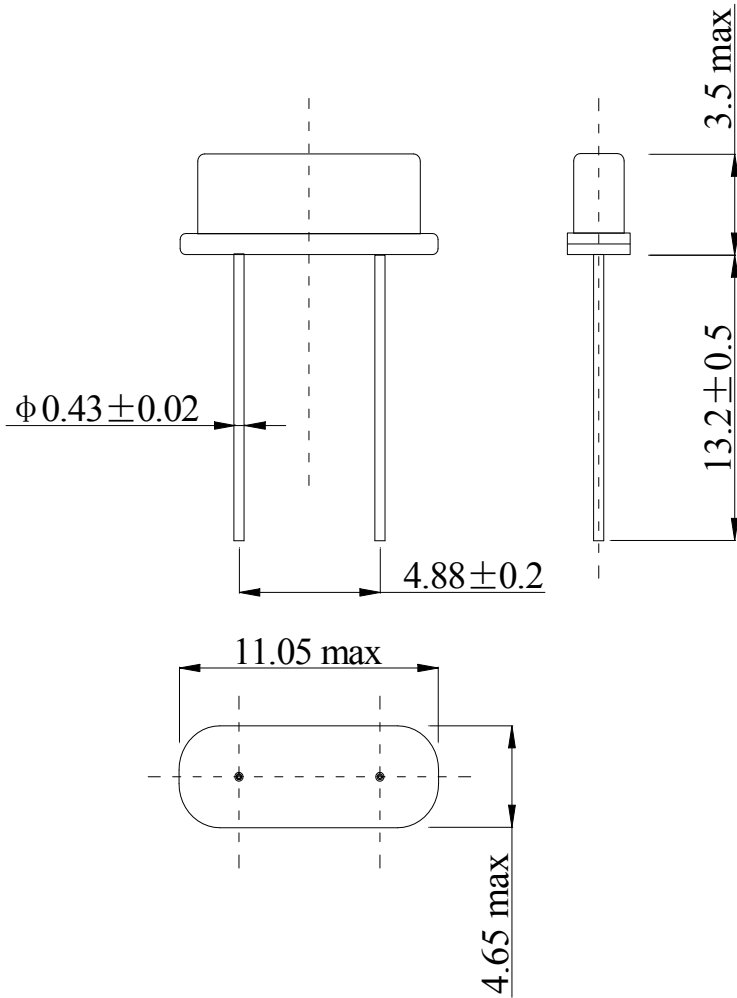

*Marking should be printed as following:

Logo, Nominal Frequency

Logo: T

Nominal Frequency: (ex. 3.579545MHz $\sqrt{3.579545}$)

Marking: Laser marking

CHIP SUN TECHNOLOGY CO., LTD.

DESCRIPTION	HC-49/S 6.7458MHz ± 20 ppm 20pF	Page:
DATE	2023-03-17	4 / 6

3.MECHANICAL/ENVIRONMENTAL CHARACTERISTICS

NO.	项 目 ITEM	条 件 CONDITIONS	规 格 SPECIFICATIONS
3.1	漏气试验 Leaking Test	完全浸入 90±3℃热水中 3 分钟。 Fully immersed into hot water at 90℃ ±3℃ for 3 minutes.	无气泡存在 no air bubble are visible.
3.2		用氦质谱仪测试或加压测绝缘电阻 Take measurements with a helium leakage detector, or measure insulation resistance under pressure.	1×10 ⁻⁸ Pa.m ³ /s Max or IR≥500MΩ
3.3	跌落试验 Drop Test	高度 75cm, 自由落体于 3cm 木板上, 6 次 Dropping 6 times from the height of 75 cm onto hard wooden board of thickness more than 30mm.	频率变化±5ppm 以内, 电阻变化 15%以内 The crystal must meet: Δf≤±5ppm ΔR≤15%
3.4	振动试验 Vibration Test	频率 10~55Hz, 振幅 1.5mm, 时间 1.5 分钟循环, 在 XYZ 方向各 2 小时。 Vibration Frequency: 10~55Hz Cycle: 1.5 Min. Amplitude: 1.5mm P-P. Direction: X.Y.Z Time: 2 Hours / Each Direction	频率变化±5ppm 以内, 电阻变化 15%以内 The crystal must meet: Δf≤±5ppm ΔR≤15%
3.5	可 焊 性 Solderability Test	从引线末端至距底部 2mm 处放入 230℃ ±5℃ 焊槽内,时间: 5±0.5 秒。 The terminal lead wire is to be soaked in a 230℃ ±5℃ tin trough for 5±0.5 seconds.	沾锡面≥90%. 频率变化±5ppm 以内, 电阻变化 15%以内 Tin over the wire≥90% The crystal must meet: Δf≤±5ppm ΔR≤15%
3.6	耐低温性 Low Temperature Enduring	在-40℃ ±3℃下,放置 96 小时,取出后在常温下恢复 2 小时。 The samples crystal is to be tested after being placed in the environment of -40C ±3℃ for 96 hours, and recovered to room temperature for 2 hours.	频率变化±5ppm 以内, 电阻变化 15%以内 The crystal must meet: Δf≤±5ppm ΔR≤15%
3.7	耐高温性 High Temperature Enduring	在+85℃ ±3℃下放置 96 小时,取出后在常温下恢复 2 小时。 The samples crystal is to be tested after being heated at +85 ±3℃ for 96 hours, and cooled to room temperature for 2 hours.	频率变化±5ppm 以内, 电阻变化 15%以内 The crystal must meet: Δf≤±5ppm ΔR≤15%

CHIP SUN TECHNOLOGY CO., LTD.

DESCRIPTION	HC-49/S 6.7458MHz ±20ppm 20pF	Page:
DATE	2023-03-17	5 / 6

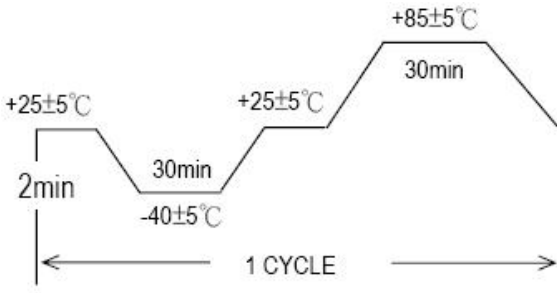
3.8	恒定湿热 Humidity	<p>在 $40\pm 3^{\circ}\text{C}$、RH $93\%\pm 2\%$下放置 96 小时,取出后恢复 2 小时。 The temperature is at $40\pm 3^{\circ}\text{C}$, and at $93\%\pm 2\%$ RH after 96 hours, and cooled to room temperature for 2 hours.</p>	<p>外观无异常, 频率变化$\pm 5\text{ppm}$ 以内, 电阻变化 15%以内 The crystal must meet: $\Delta f \leq \pm 5\text{ppm}$ $\Delta R \leq 15\%$</p>
3.9	耐焊接热 Resistance to Solder Heat	<p>引线端子应插入 $350\pm 5^{\circ}\text{C}$的焊接槽中 3 ± 0.5 秒或 $260\pm 5^{\circ}\text{C}$的焊接槽中 10 ± 0.5 秒,插入深度为从引线末端至距底部 2mm 处,而后放在自然环境中 1 小时,再进行测试。 Lead terminals are immersed up to 1.5mm from resonator's body in soldering bath of $350\pm 5^{\circ}\text{C}$ for 3 ± 0.5 sec. And then resonator shall be measured after being placed in room temperature for 1 hour.</p>	<p>外观无异常, 频率变化$\pm 5\text{ppm}$ 以内, 电阻变化 15%以内 The crystal must meet: $\Delta f \leq \pm 5\text{ppm}$ $\Delta R \leq 15\%$</p>
3.10	热冲击 Thermal shock	<p>在 -40°C 保持 30 分钟, $+85^{\circ}\text{C}$ 保持 30 分钟, 循环 10 次。 Should be satisfied after supplying the following temperature cycle (10 cycles). (Refer to Fig-4). Temperature shift from low to high, high to low shall be done in $1^{\circ}\text{C}/\text{min}$.</p> 	<p>外观无异常, 频率变化$\pm 5\text{ppm}$ 以内, 电阻变化 15%以内 The crystal must meet: $\Delta f \leq \pm 5\text{ppm}$ $\Delta R \leq 15\%$</p>

4. PACKAGE 包装

4.1 Quantity of package:

250 pieces of crystal unit	per bag
2500 pieces of crystal unit	per inner box, 10 bags
25000 pieces of crystal unit	per carton, 10 inner boxes

CHIP SUN TECHNOLOGY CO., LTD.

DESCRIPTION	HC-49/S 6.7458MHz $\pm 20\text{ppm}$ 20pF	Page:
DATE	2023-03-17	6 / 6