

SENSOR SWITCH 大日科技股份有限公司

Item.#	RBS3109 Series	Description	ROLL BALL SWITCH	Version	V101.6
Page	1 of 16		Date	August 31, 2012	

● FUNCTIONS

1. Tilt Detecting within a 360° radius
2. Slight Vibration Detecting



● APPLICATIONS

1. Rotation detection for LCD monitor
2. Automatically shut off for home appliances
3. Automatically shut off for Sporting equipment
4. Automatically shut off for motorbike
5. Alarm system
6. Anti-theft / Anti-tamper devices
7. Being motion detection (personal locator)
8. Wake up systems for power saving, such like remote controllers
9. Earthquake Detecting

● FEATURES

1. Housing made of high insulation plastic material, free from electric conduction and rust problem.
2. Detecting with photo transistors, generating highly reliable and stable signals.
3. All plastic materials subject to industrial purpose, resist high temperature and meet fireproof function.
4. Simple ON and OFF signals, easy for design.
5. Suitable to vertical PCB.
6. Tilt Angles: 15°, 20°, 30°, and 45° within a 360° radius.
7. RoHS compliance, an ideal substitute for mercury switch.
8. A more economical tilt and vibration detection option than IC design solution.
9. All made in Taiwan and examined before shipment.



SENSOR SWITCH 大日科技股份有限公司

Item.#	RBS3109 Series	Description	ROLL BALL SWITCH	Version	V101.6
Page	2 of 16		Date	August 31, 2012	

● PATENTS

1. Taiwan Patent No. I 310952
2. Taiwan Patent No. 181431
3. USA Patent No. US 6,800,841 B1
4. USA Patent No. US 7,402,791 B2
5. China Patent No. ZL 200610083013.5
6. China Patent No. ZL 200820126206.9
7. Japan Patent 4384217
8. Japan Patent No. 3148127

● DIMENSIONS / OPERATION / P.C.B. LAYOUT (Unit: mm, Tolerance: ±0.25mm)

<p>RBS 31 09 10</p>	<p>Operation Angle</p> <p> Hi district (55°~180°) (-55°~180°) Lo district (0°~35°) (0°~-35°) Uncertain (35°~55°) (-35°~-55°) </p>
<p>P.C.B. Layout(SMT)/Top View</p>	<p>Application Circuit</p>



SENSOR SWITCH 大日科技股份有限公司

Item.#	RBS3109 Series	Description	ROLL BALL SWITCH	Version	V101.6
Page	3 of 16		Date	August 31, 2012	

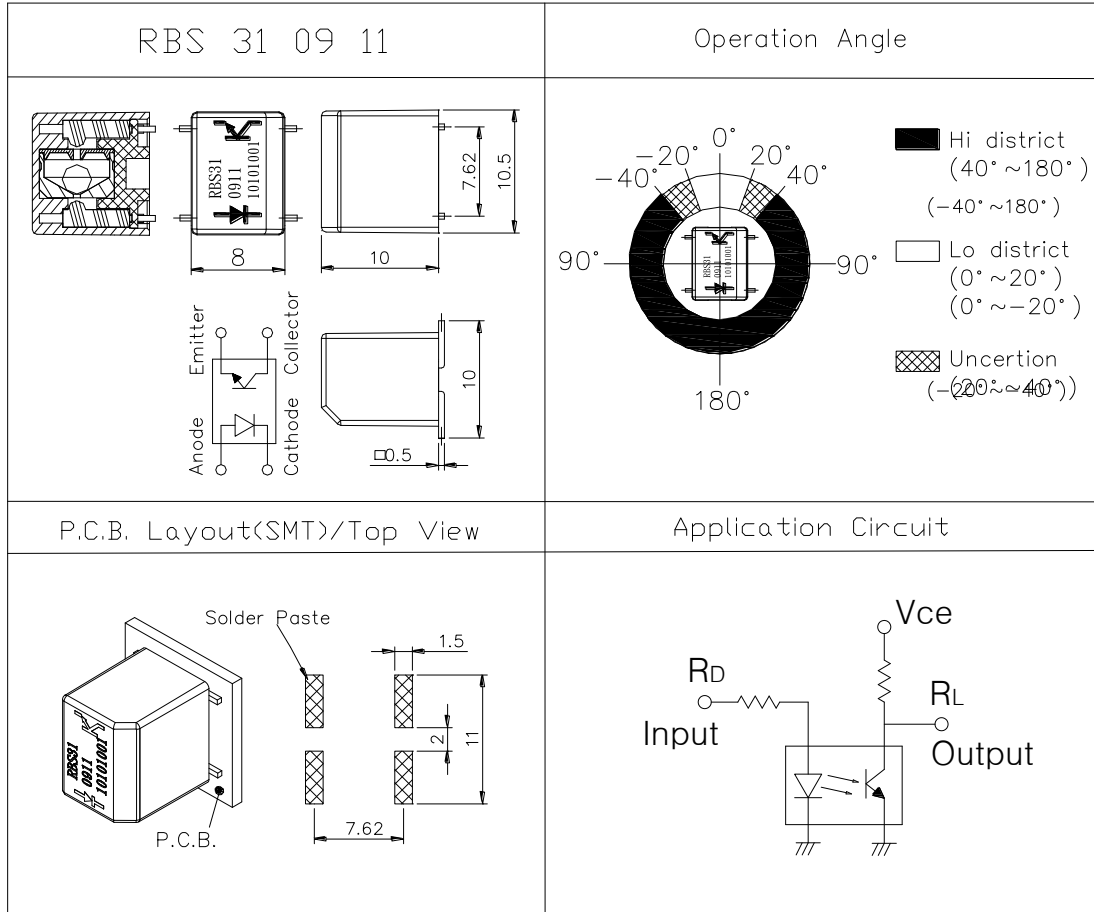

SENSOR SWITCH 大日科技股份有限公司

Item.#	RBS3109 Series	Description	ROLL BALL SWITCH	Version	V101.6
Page	4 of 16		Date	August 31, 2012	

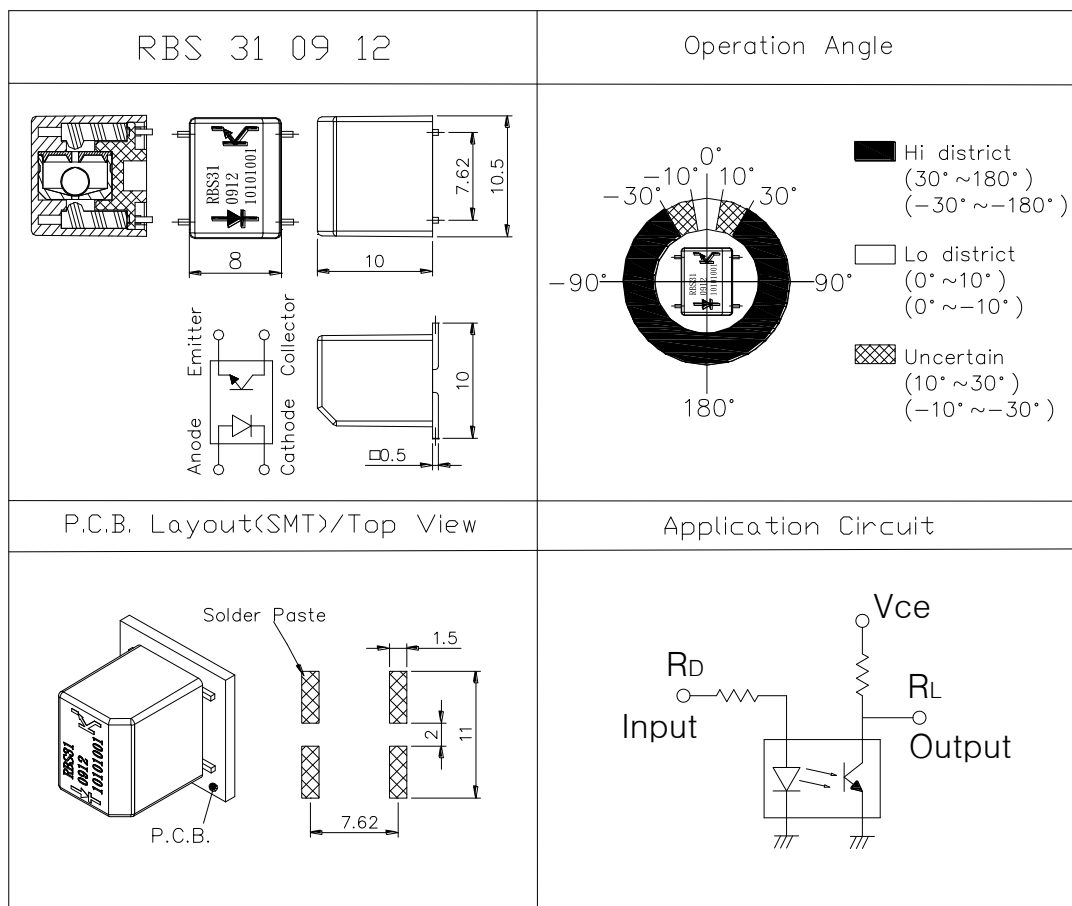

SENSOR SWITCH 大日科技股份有限公司

Item.#	RBS3109 Series	Description	ROLL BALL SWITCH	Version	V101.6
Page	5 of 16		Date	August 31, 2012	

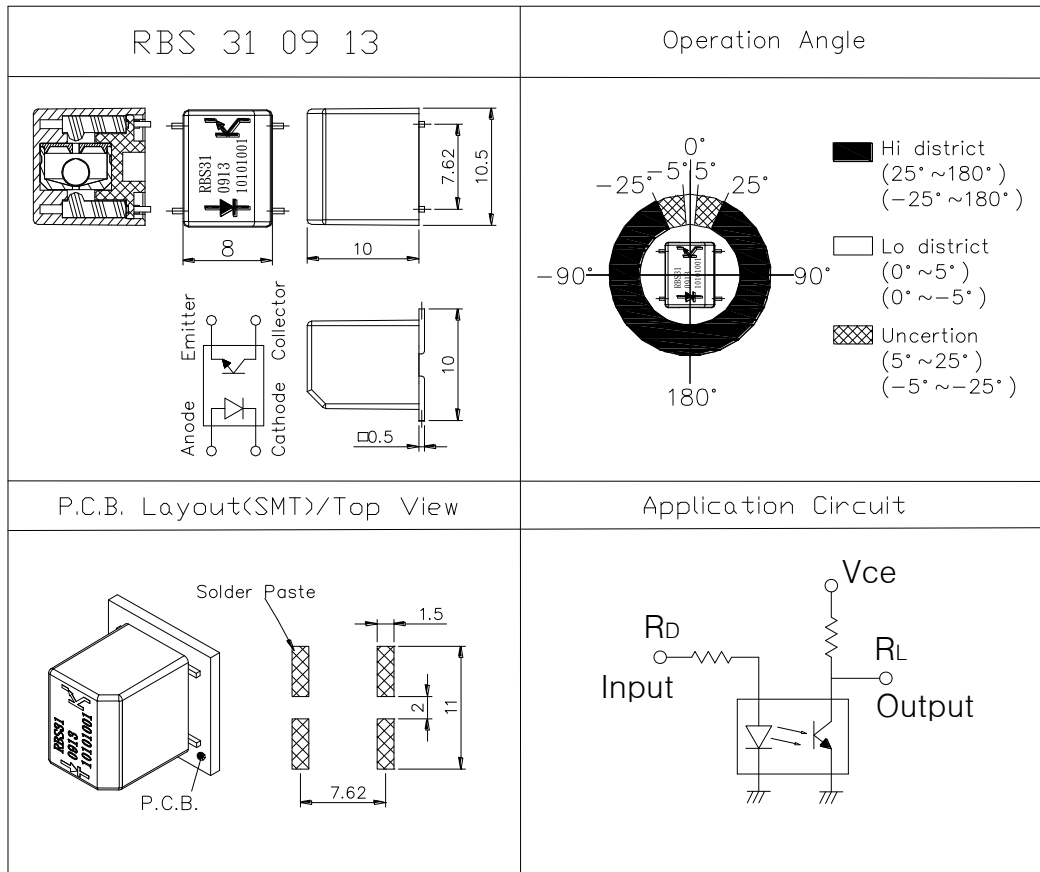

SENSOR SWITCH 大日科技股份有限公司

Item.#	RBS3109 Series	Description	ROLL BALL SWITCH	Version	V101.6
Page	6 of 16		Date	August 31, 2012	

RBS 31 09 42	Operation Angle
P.C.B. Layout(SMT)/Top View	Application Circuit



SENSOR SWITCH 大日科技股份有限公司

Item.#	RBS3109 Series	Description	ROLL BALL SWITCH	Version	V101.6
Page	7 of 16		Date	August 31, 2012	

RBS 31 09 62	Operation Angle
P.C.B. Layout(SMT)/Top View	Application Circuit

● Current/Voltage/Conditions Suggested

Input Current (mA)	Operating Voltage (V)	Conditions
10	5	Vce=5V RD=470ohm RL=33Kohm



SENSOR SWITCH 大日科技股份有限公司

Item.#	RBS3109 Series	Description	ROLL BALL SWITCH	Version	V101.6
Page	8 of 16		Date	August 31, 2012	

● Absolute Maximum Rating (Ta=25°C)

Item		Symbol	Rating	Unit
Input	Power Dissipation	Pd	75	mW
	Reverse Voltage	Vr	5	V
	Forward Current	IF	50	mA
	Peak Forward Current (*1)	IFP	1	A
Output	Collector Power Dissipation	Pc	100	mW
	Collector Current	Ic	20	mA
	C-E Voltage	VCEO	30	V
	E-C Voltage	VECO	5	V
Operating Temperature		Topr	-25~+85	°C
Storage Temperature		Tstg	-40~+100	°C
Soldering Temperature (*2)		Tsol	260	°C

(*1) tw=100 uSec. ∙ T=10 mSec.

(*2) t=5 Sec



SENSOR SWITCH 大日科技股份有限公司

Item.#	RBS3109 Series	Description	ROLL BALL SWITCH	Version	V101.6
Page	9 of 16		Date	August 31, 2012	

● Electrical Optical Characteristics (Ta=25°C)

Parameter	Symbol	Condition	Min.	Typ.	Max.	Unit
Forward Voltage	VF	IF=20mA	-	-	1.5	V
Reverse Current	IR	VR=5V	-	-	10	μA
Peak Wavelength	λp	IF=10mA		940		nm
Dark Current	ID	VCE=10V	-	-	2	μA
C-E Saturation Voltage	VCE (sat)	IC=0.25mA IF=20mA	-	-	0.4	V
Light Current	IL	VCE=5V IF=20mA	0.5	5	-	mA
Rise Time	Tr	IC=0.8mA	-	5	-	μsec
Fall Time	Tf	Vcc=30V RL=1KΩ	-	5	-	μsec



SENSOR SWITCH 大日科技股份有限公司

Item.#	RBS3109 Series	Description	ROLL BALL SWITCH	Version	V101.6
Page	10 of 16		Date	August 31, 2012	

● Typical Electrical / Optical Characteristics Curves (Ta=25°C)

Fig.1 Power Dissipation vs. Ambient Temperature

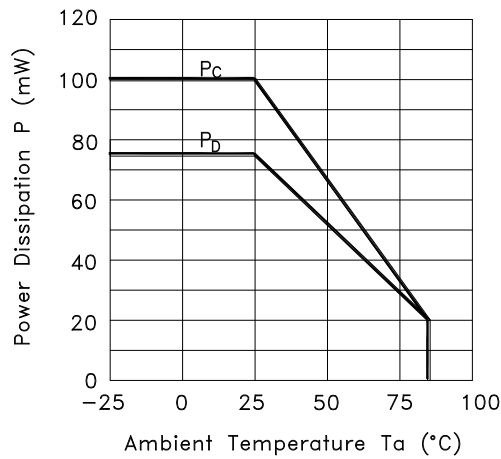

Fig.2 Forward Current vs. Forward Voltage

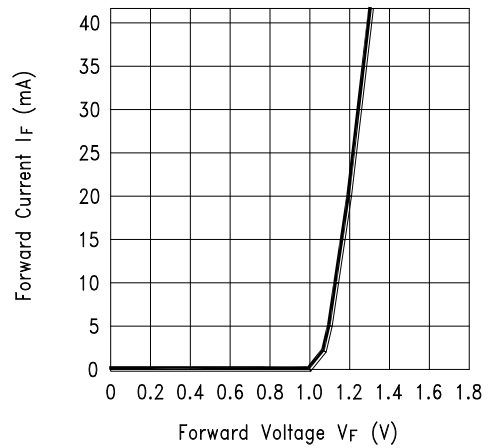

Fig.3 Collector Current vs. Collector-emitter Voltage

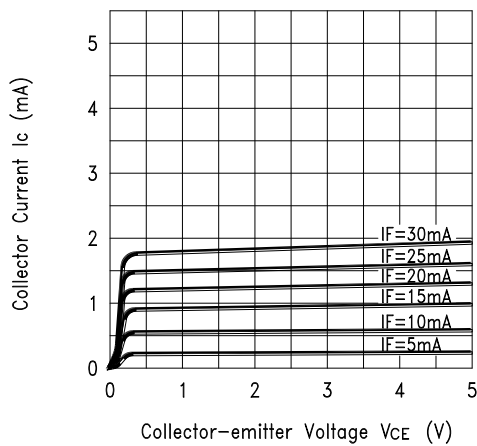
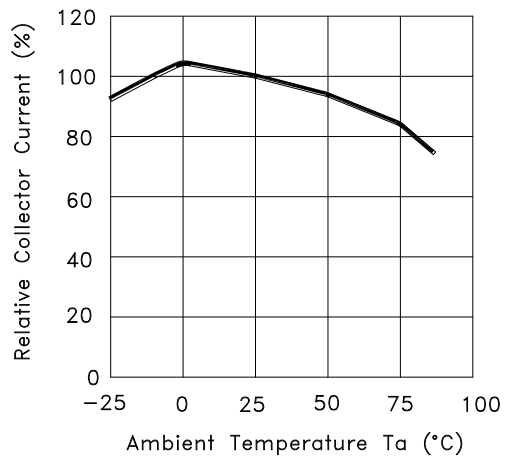

Fig.4 Collector Current vs. Ambient Temperature



SENSOR SWITCH 大日科技股份有限公司

Item.#	RBS3109 Series	Description	ROLL BALL SWITCH	Version	V101.6
Page	11 of 16		Date	August 31, 2012	

Fig.5 Collector-emitter Saturation Voltage vs. Ambient Temperature

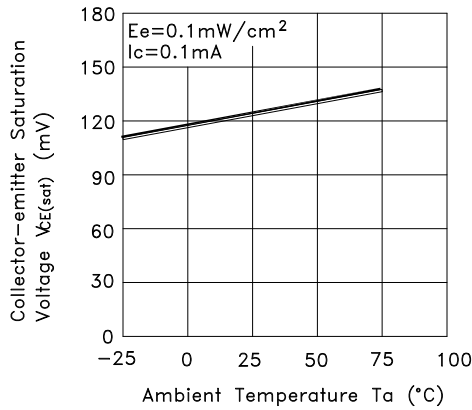

Fig.6 Response Time vs. Load Resistance

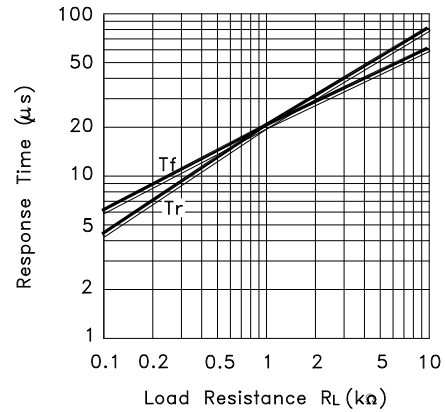
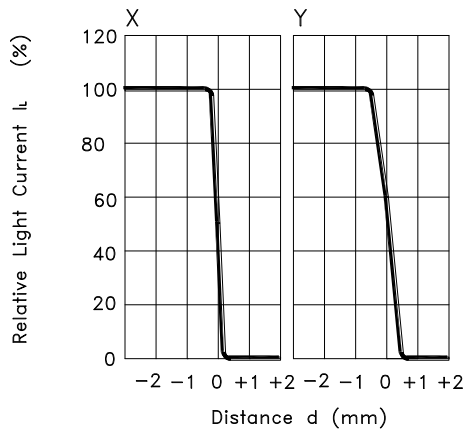
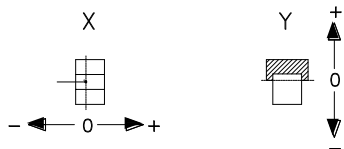

Fig.7 Sensing Position Characteristics (Typical)



(Center of Optical axis)



Test Circuit for Response Time

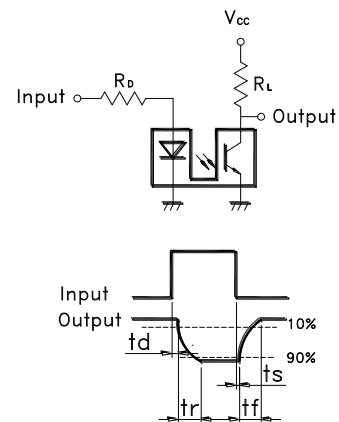

SENSOR SWITCH 大日科技股份有限公司

Item.#	RBS3109 Series	Description	ROLL BALL SWITCH	Version	V101.6
Page	12 of 16		Date	August 31, 2012	

● ELECTRICAL CHARACTERISTICS

1	Contact Rating	--
2	Contact Resistance	--
3	Angle Tolerance	Please see above illustration
4	Insulation Resistance	--
5	Dielectric Strength	--
6	Capacitance	--

● Reliable Test Items

Reliable Test

Test Item	Standard	Test Content
IR Reflow	MIL-STD-202G, TEST METHOD 210F、 IPC/JEDEC J-STD-020D	Peak temp.=255~260°C *3times
Operation Temperature	MIL-STD-202G, TEST METHOD 107G, TEST A	-25°C~85°C
Storage Temperature	MIL-STD-202G, TEST METHOD 107G, TEST A	-40°C~85°C
Humidity	MIL-STD-202G, TEST METHOD 103B	40°C/95%RH
Mechanical Life	--	2Hz horizontal/1,000,000 times
Operation Life	MIL-STD-883E:1016	IF=20 mA VCE=5 V TIME:1,000 hrs
Pull Force of Terminal	--	500 GF · 1 minutes



SENSOR SWITCH 大日科技股份有限公司

Item.#	RBS3109 Series	Description	ROLL BALL SWITCH	Version	V101.6
Page	13 of 16		Date	August 31, 2012	

● IR Reflow Reference Profile (For SMT Type)

Following reflow information is for reference only, we suggest users to process as per the recommendation of soldering flux manufacturer.

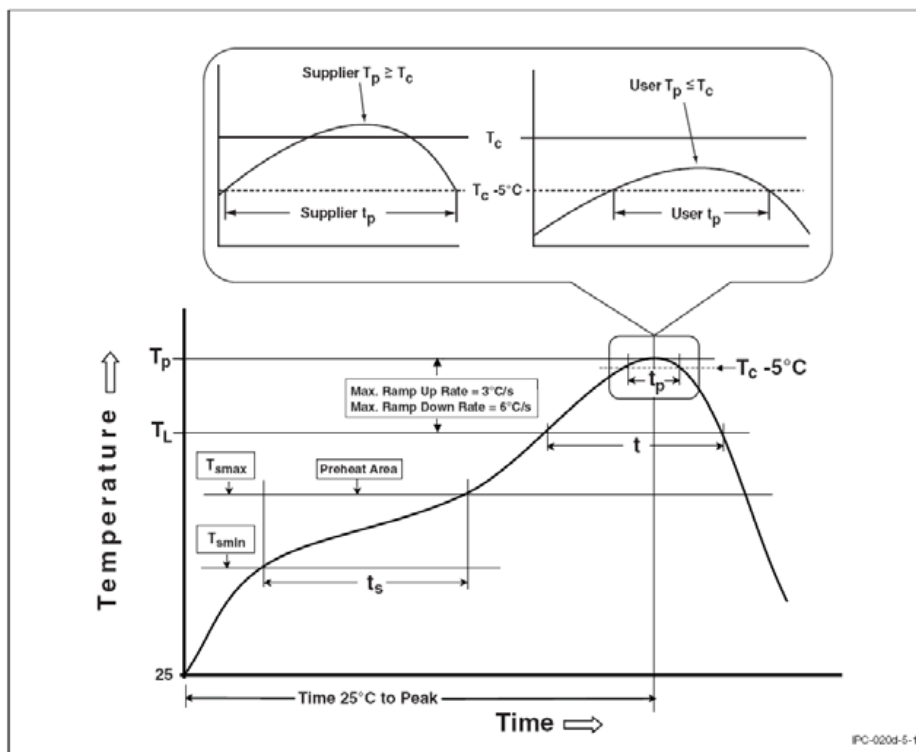

SENSOR SWITCH 大日科技股份有限公司

Item.#	RBS3109 Series	Description	ROLL BALL SWITCH	Version	V101.6
Page	14 of 16		Date	August 31, 2012	

< Table of classification Reflow profile >

Item	Pb process	Pb free process
Pre-heat and Soak Temperature min.(T _{min}) Temperature max.(T _{max}) Time (T _{min} to T _{max})(ts)	100 °C 150 °C 60-120 seconds	150 °C 200 °C 60-120 seconds
Average ram-up Rate (T _{max} to T _p)	3 °C/second max.	3 °C/second max.
Liquidous Temperature (TL) Time at Liquidous (tL)	183 °C 60-150 seconds	217 °C 60-150 seconds
Peak package body Temperature (T _p)*	230 °C ~235 °C *	255 °C ~260 °C *
Classification temperature(T _c)	235 °C	260 °C
Time(tp)** within 5 °C of the specified classification temperature (T _c)	20** seconds	30** seconds
Average ram-down Rate (T _p to T _{max})	6 °C/second max.	6 °C/second max.
Time 25 °C to peak temperature	6 minutes max.	8 minutes max.
* Tolerance for peak profile temperature (T _p) is defined as a supplier minimum and a user maximum. ** Tolerance for time at peak profile temperature (tp) is defined as a supplier minimum and a user maximum.		

Condition Operation Method	Soldering Temperature	Soldering Time
Manual Soldering	260±5°C	<5 sec. Max
Wave Soldering	260±5°C	<5 sec. Max



SENSOR SWITCH 大日科技股份有限公司

Item.#	RBS3109 Series	Description	ROLL BALL SWITCH	Version	V101.6
Page	15 of 16		Date	August 31, 2012	

● PACKAGE

	Part Number	Package	Quantity	Total	Size(mm)
1.	RBS310910T	Tape & Reel	350 pcs	350 pcs	φ330*25H
	RBS310911T				
	RBS310912T	Inner Box	2 Reels	700 pcs	355L*340W*68H
	RBS310913T				
	RBS310915T				
	RBS310942T	Carton	10 Boxes	7,000 pcs	705L*365W*375H
RBS310962T					

※ Package shown as below for reference.

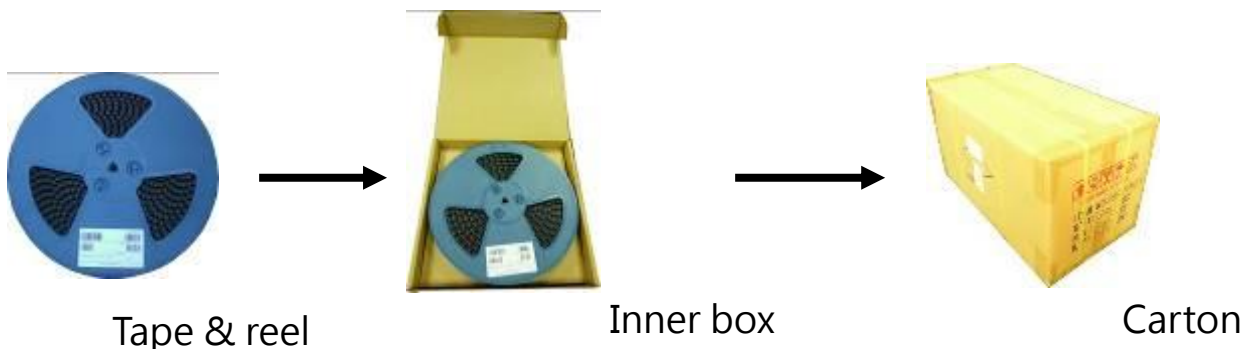

SENSOR SWITCH 大日科技股份有限公司

Item.#	RBS3109 Series	Description	ROLL BALL SWITCH	Version	V101.6
Page	16 of 16		Date	August 31, 2012	

● NOTES

1. Suggestion for usage : For vibration usage or application · we suggest to add hysteresis for IC.
2. For the continued product improvement as one of the company policy, specifications may change or update without notice. The latest information can be obtained through our sales offices. Normally, all products are supplied under our standard conditions.

● PRECAUTIONS FOR USE

1. If the products is intended to be used for other endurance equipment requiring higher safety and reliability such as life support system, space and aviation devices, disaster and safety system, it's necessary to make verification of conformity or contact us for the details before using.
2. Do not try to clean the switch with a solvent or similar substance after the soldering process.
3. Use water-soluble flux may damage the switch.
4. When the soldering temperature exceeds specifications, the switch may fall apart.
5. Do not use switch in the environment of high humidity · because such an environment may cause the leakage current between the terminals.
6. More than the rated load may cause fire, so do not use more than the load
7. In the circuit · switch should not be near or directly connected with the magnetic component solder joints (for example: relays, transformers, etc.).

