

Sample Approval Sheet

产品类别(Product type):SMD		
产品名称(Product name): 0603 Orange		
产品编号(Part No.):		
样品编号(Sample No.):		
承认书编号(Acknowledgement Numbers):20151023006		
签核 (Signatures)		
核准(Approved)	审核(Checked)	制定(Drawn)

客户 (Customer)		
公司名称(Corporation):		
物料编码(Material No.):		
物料名称(Part No.):		
客户确认 (Customer Signatures)		

Feature

- *Low power consumption
- *Long life-solid state reliability
- *Available on tape and reel
- *RoHS compliant

Package outline dimensions (产品外型尺寸)

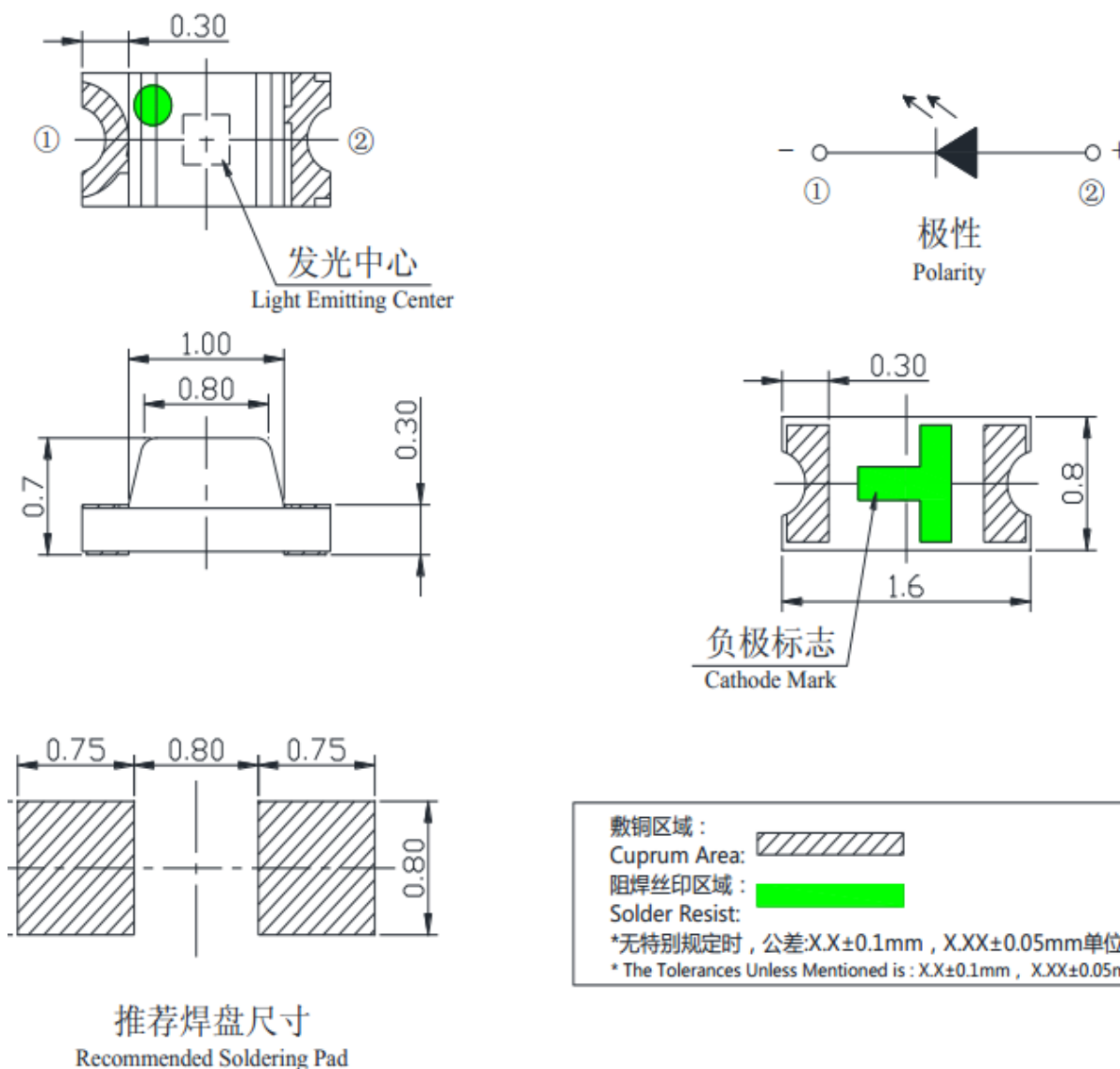

Note:

1. All dimensions are in millimeters (mm);
2. X.X is +/-0.1mm, X.XX is +/- 0.05mm unless otherwise noted;
3. The device has a single mounting surface, the device must be mounted according to the specifications.

Electrical characteristics data sheet

Selection Guide (选用指示)

Part No. (产品型号)	Emitted Color (发光颜色)	Resin color (胶体颜色)	Viewing Angle (发光角度) $2\theta_{1/2}$
	Orange	Clear	130°

Absolute Maximum Ratings at Ta=25°C (极限参数)

Parameter (项目)	Symbol (符号)	Value (数值)	Unit (单位)
Power dissipation (功率消耗)	Pd	65	mW
DC Forward Current (正向电流)	If	25	mA
Peak Forward Current ⁽¹⁾ (峰值电流)	Ifp	50	mA
Reverse Voltage (反向电压)	Vr	5	V
Electro-Static-Discharge ⁽²⁾ (HBM)	ESD	2000	V
Operating Temperature (工作环境温度)	Topr	-30to+85	°C
Storage Temperature (储存温度)	Tstg	-40to+100	°C
Lead Solder Temperature (焊接温度)	Tsol	250 for 5sec	°C

Notes:

- 1/10 duty cycle, 0.1ms pulse width
2. The products are sensitive to static electricity and must be carefully taken when handling products.

Electrical/Optical Characteristics Ta=25°C (电子光学特性)

Parameter (参数)	Symbol (符号)	Condition (条件)	Value (数值)			Unit
			Min.	Typ.	Max.	
Forward voltage (正向电压)	Vf	If=20mA	1.6	2.0	2.6	V
Luminous intensity (发光强度)	Iv	If=20mA	80	120	---	mcd
Dominant wavelength (主波长)	λ_d	If=20mA	598	605	610	nm
peak wavelength (峰值波长)	λ_p	If=20mA	--	612	--	nm
Spectrum Radiation Bandwidth (半波宽度)	$\Delta\lambda$	If=20mA	--	---	24	nm
Reverse current (反向电流)	Ir	Vr=5V	---	---	10	μ A

Notes:

1. Forward voltage: $\pm 0.1V$
2. Wavelength: $\pm 1.5nm$
3. Radiant intensity: $\pm 10\%$

Typical Electro-Optical Characteristics Curves

FORWARD CURRENT VS. FORWARD VOLTAGE

电流与电压的关系图

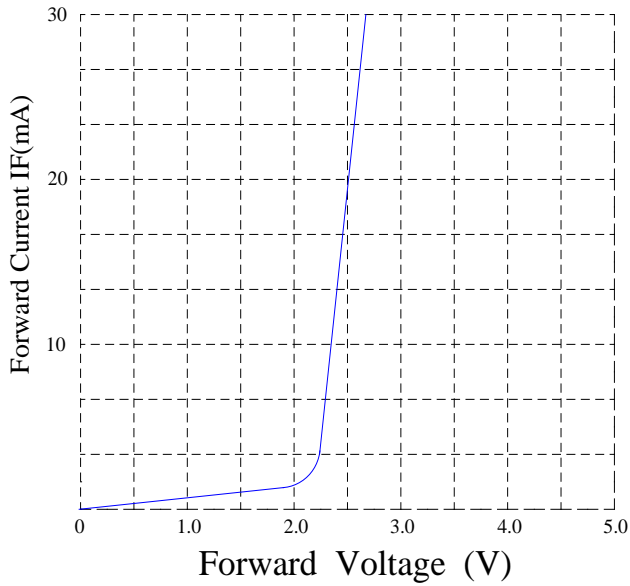

FORWARD CURRENT VS. LUMINOUS INTENSITY

电流与光强的关系图

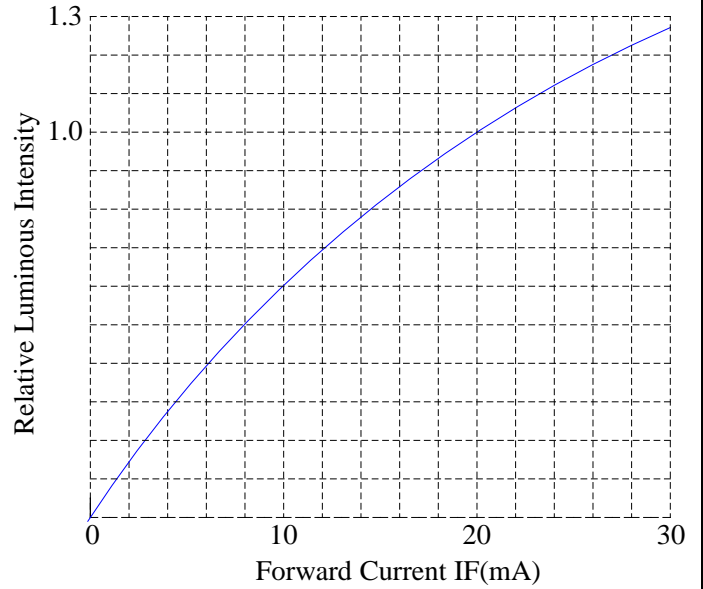

AMBIENT TEMPERATURE VS. FORWARD CURRENT
电流与温度的关系图

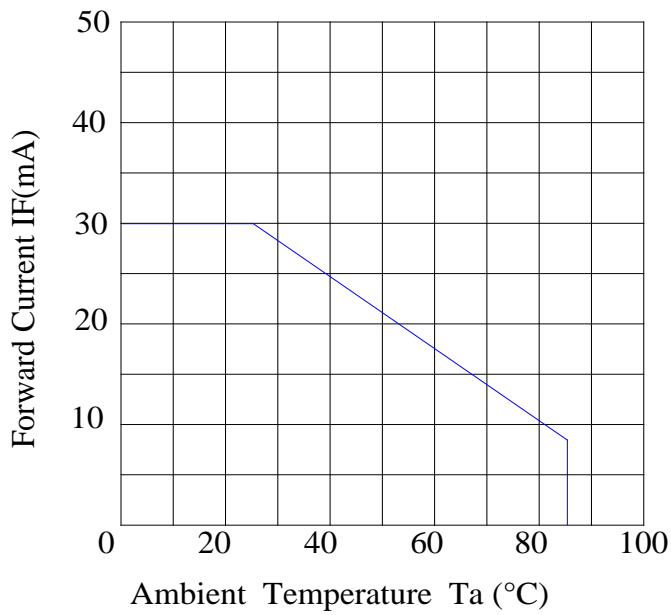

RADIATION DIAGRAM
视角图

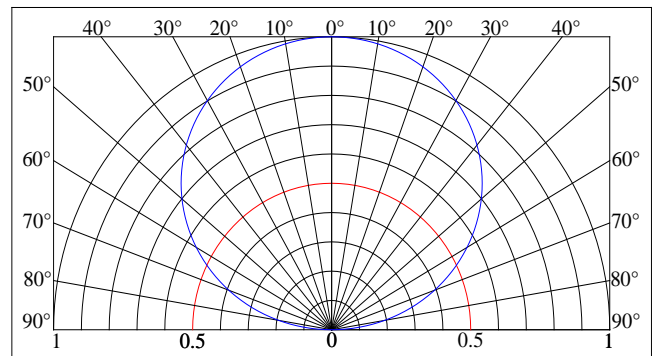

Bin Range of Technical Data Sheet

Voltage code (电压等级) (IF=20mA, Ta=25°C)			Luminous code(光强等级) (IF=20mA, Ta=25°C)		
Bin Code	Forward voltage (V)		Bin Code	Luminous Intensity (mcd)	
	min	max		min	max
D	1.6	1.8	4	80	100
E	1.8	2.0	5	100	120
F	2.0	2.2	5	120	160
G	2.2	2.4	6	160	210
H	2.4	2.6			

Color Bin Limits

Color code (颜色等级) (IF=20mA, Ta=25°C)		
Bin Code	Dominant wavelength (nm)	
	min	max
1	598	601
2	601	604
3	604	607
4	607	610

Reliability Test Items and Conditions(可靠性试验及条件)

1、Test items and result(测试项目及结果)

Test Item 测试项目	Ref. Standard 参考标准	Test Condition 测试条件	Note 记录	Number of Damaged 受损数量
Resistance to Soldering Heat (耐热测试)	JESD22-B106	Tsld=260°C,10sec	2 times	0/100
Temperature Cycle (冷热循环)	JESD22-A104	-40°C 30min ↓↑ 5min 100°C 30min	100 cycle	0/100
Thermal Shock (冷热冲击)	JESD22-A106	-40°C 15min ↑↓ 100°C 15min	100 cycle	0/100
Power temperature Cycling (高低温点亮循环测试)	JESD22-A105	On 5min -40°C>15min ↑↓↑↓<15min Off 5min 100°C>15min	100 cycle	0/100
High temperature Storage (高温储存)	JESD22-A103	Ta=100°C	1000 hrs	0/100
Low temperature Storage (低温储存)	JESD22-A119	Ta=-40°C	1000 hrs	0/100
Lift Test (寿命测试)	JESD22-A108	Ta=25°C IF=20mA	1000 hrs	0/20
High Humidity Heat Lift Test (高温高湿老化)	JESD22-A101	60°C RH=90 % IF=20mA	1000 hrs	0/20

2、Criteria for judging damage (受损失效判定标准)

Item 项目	Symbol 符号	Test Conditions 测试条件	Criteria for Judgment 判断标准	
			Min 最小	Max 最大
Forward voltage 正向电压	VF	IF=20mA	--	U.S.L*)×1.1
Reverse current 反向电流	IR	VR=5V	--	U.S.L*)×2.0
Luminous intensity 光照强度	IV	IF=20mA	L.S.L**)×0.7	--

Notes:

U.S.L.: Upper Standard Level

L.S.L.: Lower Standard Level

Packaging Dimensions Specification(包装规格)

1、Carrier tape dimensions(载带包装)

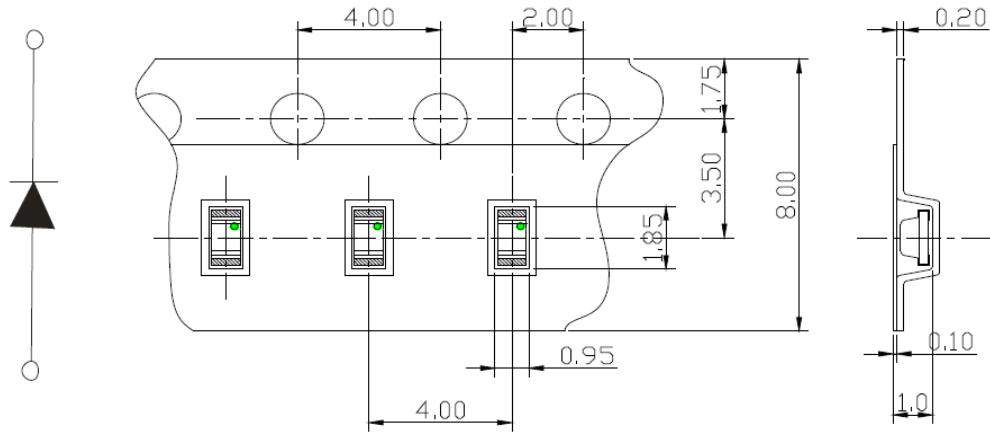

Notes:

- 1) All dimensions are in millimeters
- 2) Tolerance is ± 0.15 unless otherwise noted

2、Details of carrier tape(编带细节)

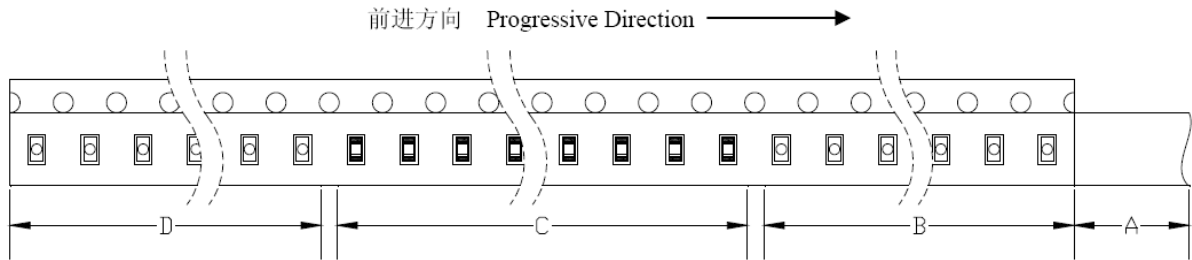

- A: 盖带, 300 mm; B: 引导, 空带, 200mm; C: 编载产品 4000 只; D: 尾部, 空带, 200mm
 A: Top Cover Tape, 300mm; B: Leader, Empty, 200mm; C: 4000 Lamps Loaded; D: Trailer, Empty, 200mm.

3、Reel dimensions(带盘尺寸)

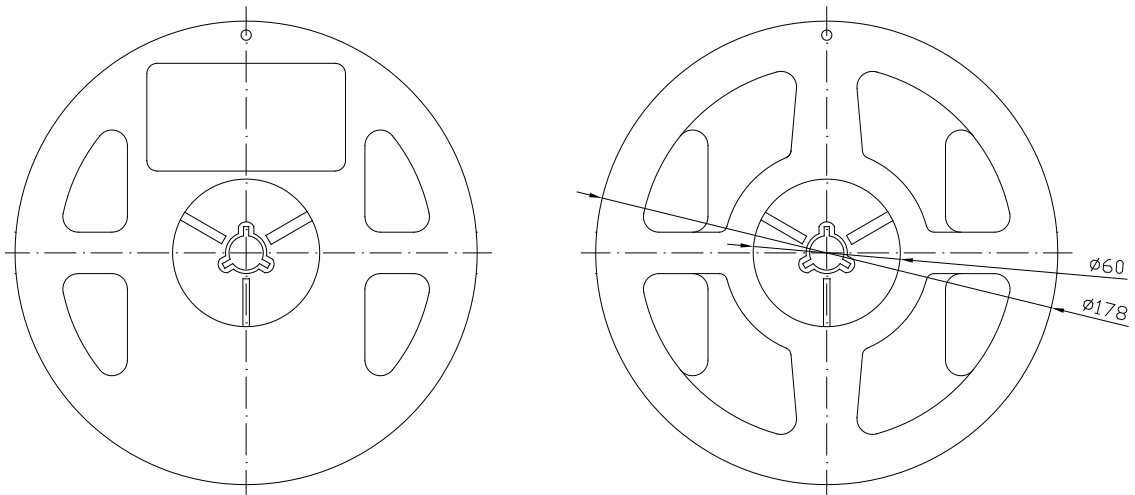

Packaging Dimensions Specification(包装规格)

4、Moisture-Proof and anti-static electricity(防潮抗静电包装)

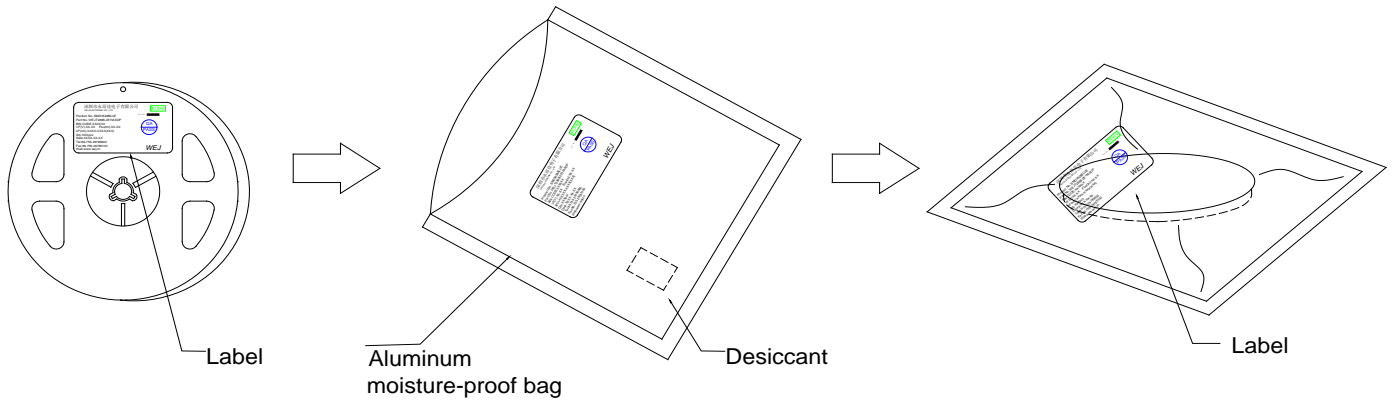

5、Label(标签)

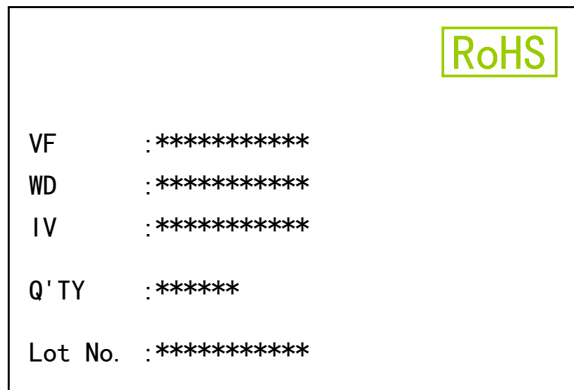

Label Explanation:

VF : Forward voltage (正向电压)
 WD : Dominant wavelength (主波长)
 IV : Luminous intensity (发光强度)
 VF\WD\IV used to represent the corresponding Bin code

Precautions(使用注意事项)

1、Requirements for application and reflow soldering 应用及回流焊要求:

Use the recommended curve in the under figure of Pb-free reflow soldering.

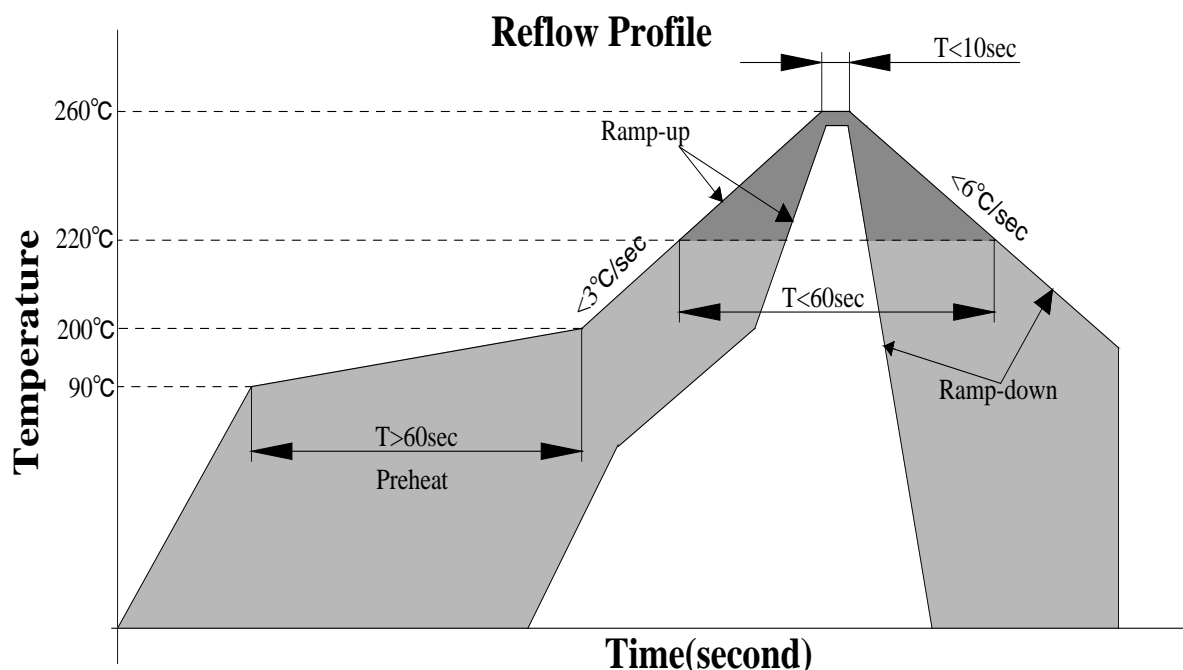

☆Notes for reflow soldering: 回流焊注意事项

- 1) No more than twice for reflow soldering.
注意回流焊不可超过两次。
- 2) To ensure the quality of our LEDs, please do not put pressure on the lens of LEDs.
为保证产 LED 质量及可靠性, 不可施加压力在 LED 胶体表面。
- 3) Please choose the right nozzle to avoid the damage to products due to the pressure.
在吸嘴的选取上要选择吸嘴的大小和压力合适的吸嘴, 以避免造成压力过大伤害产品。
- 4) Please put on the antistatic hand loop during the use. The worktable should be with antistatic finish. The equipments must be contacted with ground.
LED 为静电敏感产品, 使用时请佩带防静电手环, 工作台做好防静电处理, 机台设备等保证接地。

☆Handwork soldering 手工焊接:

- 1) During the soldering, the electronic soldering iron must be kept under the temperature of 350°C and the soldering time must not be beyond 3 seconds. No touch between the electronic soldering iron and colloid.
手工焊接时, 要保持电烙铁温度在350摄氏度以下, 并且焊接时间小于3秒, 电烙铁不可接触胶体。
- 2) Handwork soldering is only allowed once. We won't take responsibility for more than that.
手工焊接只可进行一次, 重复焊接不保证产品是否完好。
- 3) Avoid using sharp objects to compress products Colloidal Part directly.
避免使用尖锐的物体直接接触产品胶体部分。
- 4) Please put on the antistatic hand loop during the use. The worktable should be with antistatic finish. The equipments must be contacted with ground.
LED 为静电敏感产品, 使用时请佩带防静电手环, 工作台做好防静电处理, 机台设备等保证接地。

2、Storage(储存)

- ☆Moisture proof and anti-electrostatic package with moisture absorbent material is used to keep moisture to a minimum.
Before opening the package, the product should be kept at 30°C or less and humidity less than 60%RH, and be used in six months.

本产品使用密封防潮防静电袋包装，并附有干燥剂，以保证产品不会吸潮，产品包装在开封前，产品须放在温度不高于 30℃，湿度不高于 60%RH 的环境中。

☆After opening the package, the product should be stored at 30°C or less and humidity less than 10%RH, and be soldered within 24 hours. It is recommended that the product be operated at the workshop condition of 30°C or less and humidity less than 60%RH.

产品包装开封后，产品必须储存在温度不高于 30℃，湿度不高于 10%RH 的环境中，且应该在 24 小时内使用完，建议工作环境为温度不高于 30℃，湿度不高于 60%RH。

☆If the moisture absorbent material has faded away or the LEDs have exceeded the storage time, baking treatment should be performed based on the following condition (75±5) °C for 24 hours.

对于尚未焊接的 LED，如果吸湿材料或包装失效，或者产品没有符合以上有效储存条件，烘烤可以起到一定的性能恢复效果，烘烤条件：75±5 °C，持续 24 小时。

3、Static electricity (静电防护)

☆Static electricity or surge voltage damages the LEDs. Damaged LEDs will show some unusual characteristics such as the forward voltage coming lower, or the LEDs do not light at the low current, even not light.

All devices, equipment and machinery must be properly grounded. At the same time, it is recommended that wrist bands or anti-electrostatic gloves, anti-electrostatic containers be used when dealing with the LEDs.

静电或电涌会导致产品特性发生改变，例如正向电压降低，如果情况严重甚至会损毁产品，所以在使用时必须采取有效的防静电措施；所有相关的设备和机器都应该正确接地，同时必须采取其他防止静电和电涌的措施，使用静电手环，防静电垫子，防静电工作服，工作鞋，手套，防静电容器，都是有效的防止静电和电涌的措施。

4、Vulcanization(硫化)

☆LED curing is due to sulfur being in bracket and the +1 price of silver in the chemical reaction generated Ag₂S in the process. It will lead to the capacity of reflecting of silver layer reducing, light color temperature drift and serious decline, seriously affecting the performance of the product. So we should take corresponding measures to avoid vulcanization, such as to avoid using sulphur volatile substances and keeping away from high sulphur content of the material.

LED 硫化是由于环境中的硫进入支架内部与 +1 价的银发生化学反应生成黑色 Ag₂S 的过程。该过程会导致支架镀银层的反光能力下降，色温漂移和光衰严重，很大程度上影响了产品性能。因此，在使用时应注意采取相应的防硫措施，如避免使用挥发性强的含硫物质，避免接触含硫较高的物质。

5、Safety advice for human eyes(眼睛防护)

☆Viewing direct to the light emitting center of the LEDs, especially those of great luminous intensity will cause great hazard to human eyes. Please be careful.

LED 发光时，请勿直视发光光源，特别是对于一些光强较高的 LED，强光可能伤害你的眼睛。

6、Design consideration(设计建议)

☆In designing a circuit about LED, the current through each LED must not exceed the absolute maximum rating specified for each LED. In the meanwhile, resistors for protection should be applied, otherwise slight voltage shift will cause big current change, burn out may happen.

设计带有 LED 产品的电路时，通过 LED 的电流不能超过规定的最大值，同时还需使用保护电阻，否则微小的电压变化将会引起较大的电流变化，可能导致产品损毁。