

RoHS

REVISION DATE		
ITEM	DESCRIPTION	DATE
A	Issue	

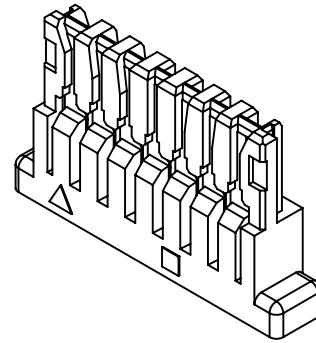

- TERMINAL
- Material: Phosphor Bronze
- Finish : Tin-plated/Gold-plated
- Thickness : 0.12±0.02mm
- Applicable Wires : AWG # 32-28
- O' d : 0.95mm MAX
- Q' ty : 15,000 Pcs/reel

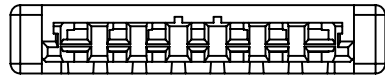
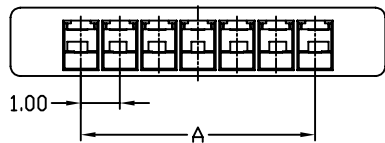
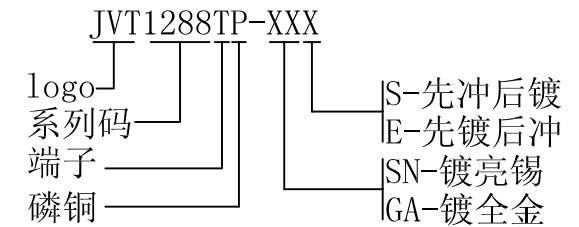
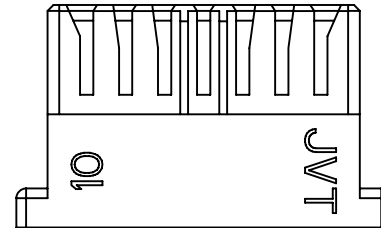
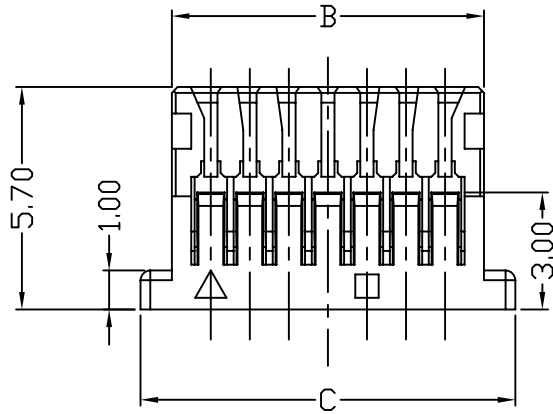
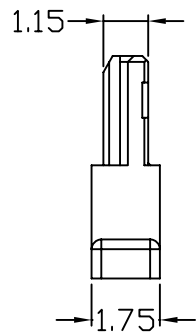

投影 (PROJECT)		公差 (TOLERANCE)
单位 (UNIT)	mm	0 ±0.40
比例 (SCALE)	FIT	0.0 ±0.30
版本 (EDITION)	A	0.00 ±0.20
日期 (DATE)	2014 03 15	0.000 ±0.05

东莞市乔业电子有限公司
DONG GUAN CHYAO YEE (JVT) CONNECTORS CO., LTD.

绘图 (DRAWN)	TONY	品号 (PART NO)	JVT1288HNO-XX	页次 (PAGE)	
审核 (CHECKED)	CHEN	图号 (DRAW NO)	031-1288-01	1/1	
核准 (APPROVE)		品名 (NAME)	SHLP 1.0mm HSG		